

PRECISION CRAFTSMANSHIP: A700 REGULATOR



- SCUBAPRO's A700 2ND STAGE
- **Unique work of art**
- **Exceptional breathing performance**
- **A regulator for maximum dive experiences**
- **The performance is unbeatable**
- Paired with a new edition of MK25 or MK17 first stages, these are phenomenal regulator systems

INTRODUCING THE A700:



Two unique regulator systems



Our history defined by regulators

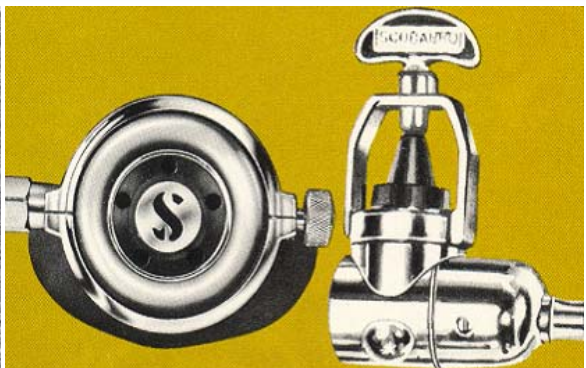

SCUBAPRO MARK I

Cat. No. 101 Scubapro regulator Mark I, precision balance valve/maximum air flow \$82.25

The Mark I with its combination of quality and simplicity marks a new standard for regulators. The simplicity of the first stage, only one moving part, establishes the Mark I as the most functional and trouble free of all SCUBA. With the exception of the first stage hose swivel system the Mark I incorporates all the features of the celebrated Mark V, including a stainless steel piston. This flow-thru piston introduces enlarged internal air passages which provide unequalled air delivery at all depths. The Mark I is balanced, that is, there is no increase in the inhalation effort as cylinder pressure is reduced. The Mark I also features the incomparable SCUBAPRO adjustable second stage. Exclusive features include a purge button that enables the diver to depress the demand lever full travel, providing full delivery of air at any depth.

SCUBAPRO, a technology and innovation leader since 1963

Our name is engraved in the history of diving





SCUBAPRO produced full metal 2nd stages since the beginning with the legendary 108, HP and MK 5. They have all set new breathing standards.

These legendary regulators were never forgotten.

The fruit of a long evolution and knowhow.

- Full metal body – The best thermal dissipation (**brass: 96 kcal/m-K, nylon: 0,25kcal/m-K**)

It is not just another full metal 2nd stage.

- It is the perfect one.



Product evolution

In 2006:

The R&D team began work on the evaluation and design of a new metal 2nd stage.



A700: An evolutionary project



Product evolution:

In 2007:

A full metal body option was retained.

It also needed to be:

Compact

Modern

Top performing superseding any other system.



The search began for the perfect materials and technology to accomplish the mission.

Many sources were investigated, including U.S. Army suppliers and untraditional liquid metal technology.



A700: An evolutionary project



Product evolution:

In 2008:

The final design was achieved.

The use of a mix of different and multiple technologies: **the best technology for each component.**

Prototypes were developed, built and tested to obtain the best **technical** and **design** results.

Mission accomplished: tooling began during the second half of 2008.

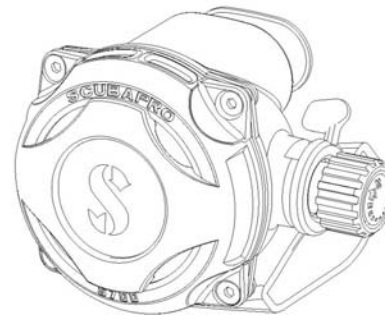
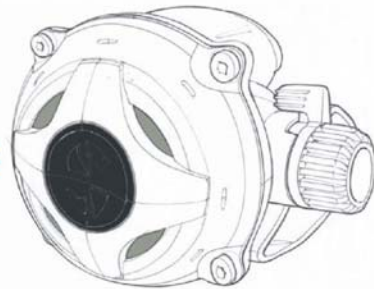
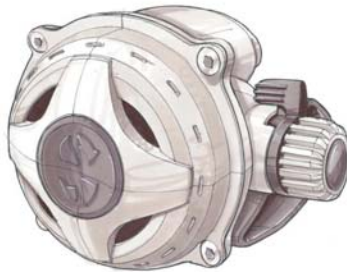
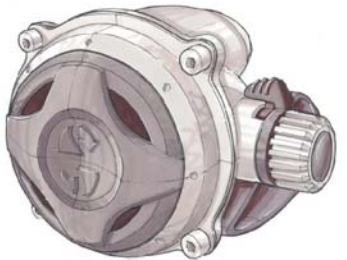



Product evolution:

2009: The Year of the Regulator

The A700 is born for a lifetime of diving experiences.

- **It is a true jewel—to be desired by many—but owned by the few.**
- It's outstanding breathing performance makes the A700 the top second stage in the world today, brought to you by SCUBAPRO.

What really makes the A700 so special?



Beauty may only be skin-deep, but there is definitely more below the surface...

- **Great breathing performance** on both inhalation and exhalation due to advanced internal aerodynamics.
- **Compact dimensions for lightness and comfort**, without compromising breathing performance.
 - Thinner case (0.8 mm) than plastic, so more compact shape.
 - The assembly with 4 visible screws for a low profile configuration.
- **Precision Handcrafted Full metal construction** for **high thermal exchange** (allows cold water diving without freezing) **and quality for a lifetime.**
- **Reliability for Life:** The A700 uses the same valve concept and diaphragm diameter of our bulletproof S600 —All the parts are time proven.



A700: Great Breathing Performance



A700 even surpasses our outstanding S600 in work of breathing performance

RESULTS
INHALE PRESSURE = 4.36 mbar (LIMIT = 25 mbar)
INHALE POS PRESSURE = 7.54 mbar (LIMIT = 5 mbar)
EXHALE PRESSURE = 9.52 mbar (LIMIT = 25 mbar)
EXT WORK OF BREATHING = 0.65 J/l (LIMIT = 3.0 Joules/litre)
INHALE WORK = 0.07 J/l
POS INHALE WORK = 0.18 J/l (LIMIT = 0.3 Joules/litre)
EXHALE WORK = 0.61 J/l

RESULTS
INHALE PRESSURE = 4.27 mbar
INHALE POS PRESSURE = 3.30 mbar
EXHALE PRESSURE = 7.12 mbar
EXT WORK OF BREATHING = 0.51 J/l
INHALE WORK = 0.06 J/l
POS INHALE WORK = 0.12 J/l
EXHALE WORK = 0.45 J/l

PRESSURE - VOLUME DIAGRAM AT DEPTH OF : 51.0 msw (167 fsw)

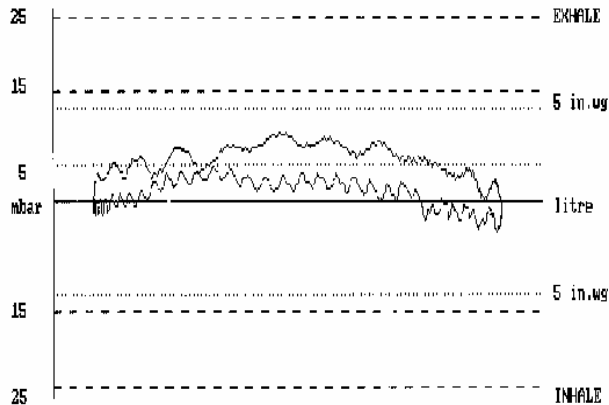

S600 (work of breathing = 0.65 J/l)

PRESSURE - VOLUME DIAGRAM AT DEPTH OF : 49.8 msw (163,4 fsw)

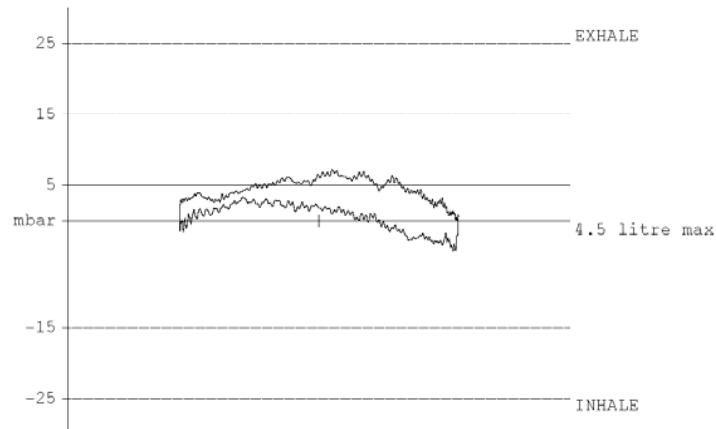

A.700 (work of breathing = 0.50 J/l)

Testing conditions: 50bar, 25bpm, 50msw



A700:Packed for Performance/Small & Solid



*Compact dimensions for lightweight comfort,
without compromising breathing performance.*

- The all metal case and front cover allowed smaller dimensions than ever.
 - Case is thinner than plastic for a more compact shape.
 - The assembly uses 4 visible screws for a low profile look and feel.
- A700 breaths big, despite it's compact size, for less weight and comfort.
- The internal configuration gives maximum performance
- Small & Solid summarizes the high technology and great performance.



Quality Construction for a Lifetime



When you purchase something this exquisite, this unique, you want to enjoy it for a lifetime.

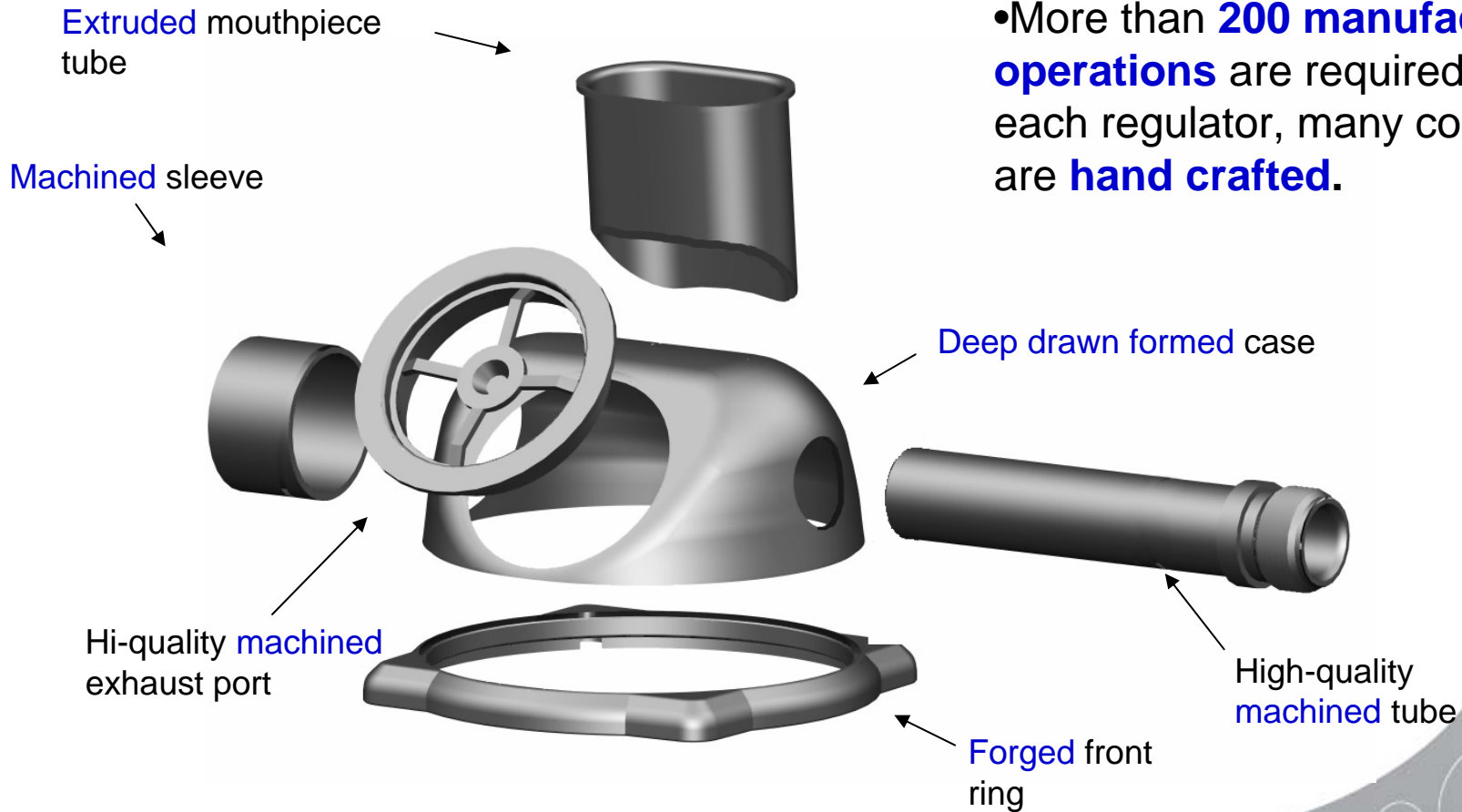

•More than **200 manufacturing operations** are required to build each regulator, many components are **hand crafted**.



- All brass components are **silver brazed** and **100% pressure tested** at 4.5 bars assuring precision construction and quality of each individual unit.

- Stringent international **Quality Control process** (Germanischer Lloyd's and Exponent) guarantees maximum reliability of all components and processes.

A700: Why does it perform so well?

Examine the A700 'inside-out'

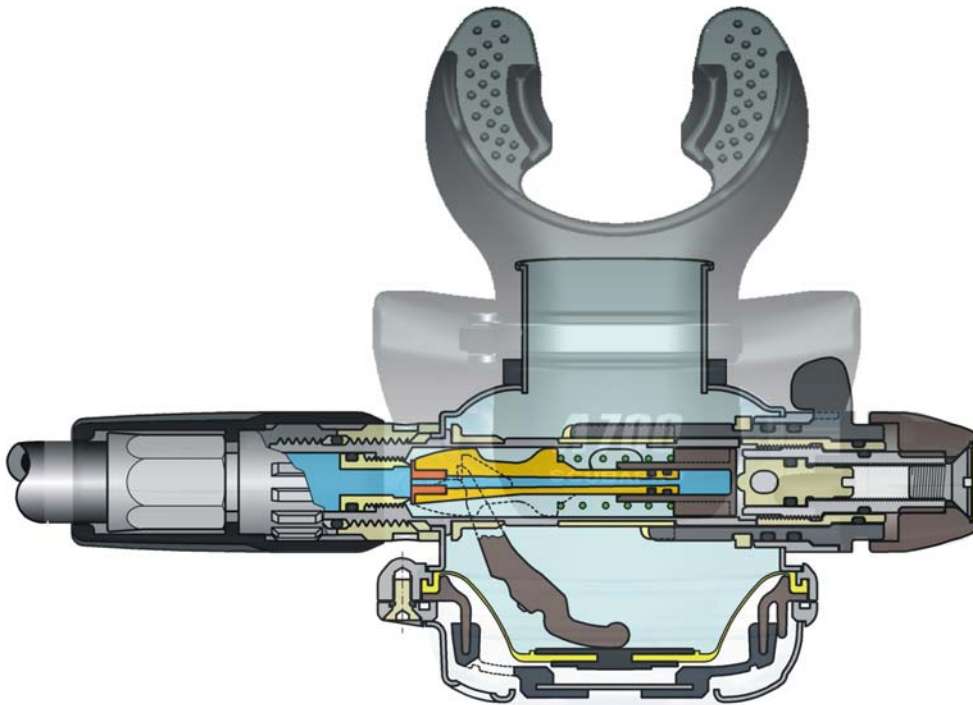

- New **aligned VIVA system** and **Micrometric Adjustment Knob** for more precise adjustment control for **better customized breathing comfort**.

VIVA uses the power of vacuum assist to reduce work of breathing.

A700: Why does it perform so well?

○○○○○



- New **co-axial 2 piece component dive switch** keeps the dimensions compact and enables less complicated after sales servicing. Airflow isn't compromised.



A700: Why does it perform so well?



Pure AERODYNAMICS

Inhale phase: airflow inlet angle is oriented by a co-axial VIVA adjustment so its easier and smoother when you inhale, no matter where or what your position.

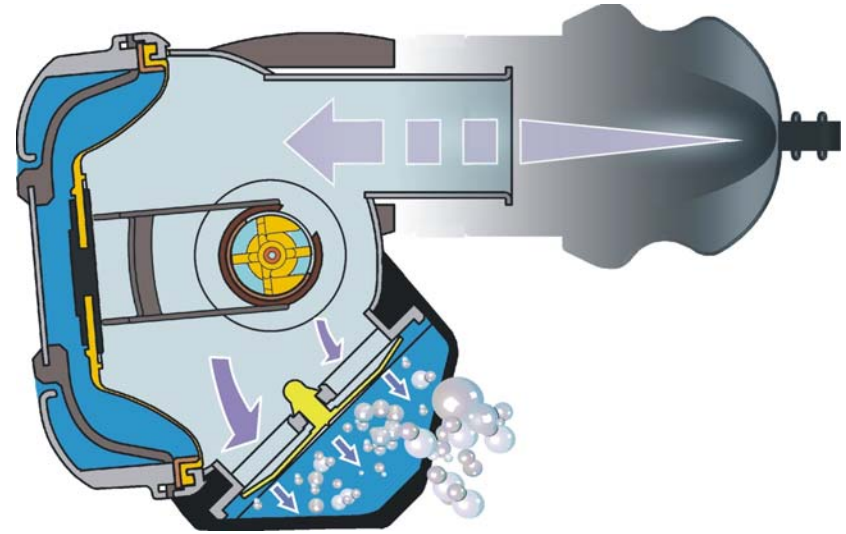
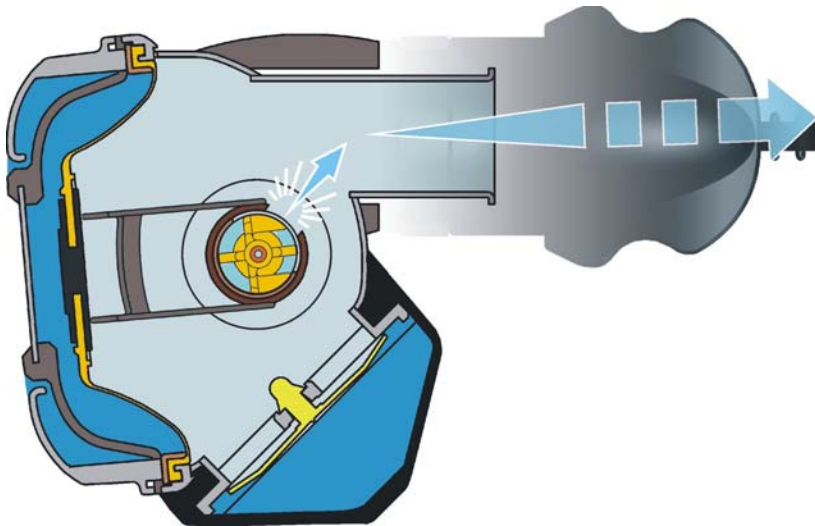

Exhale phase: mouthpiece pipe with new inclination drives the airflow out thereby reducing your exhale effort.

A700: Why does it perform so well?



Sometimes it has to do with size.

- New aerodynamic **balanced poppet** is 6mm shorter than our traditional S600 poppet. The shorter **poppet** reduces air friction and increases flow. Breathing effort has never been so low.

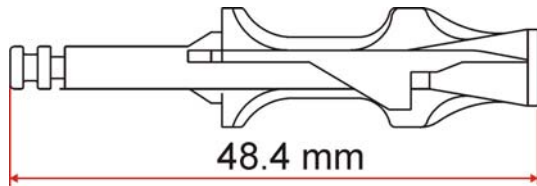

- SCUBAPRO R and D and handcrafting capabilities makes the A700 a **combination of best technologies and ultimate aerodynamics.**

A700: Why does it perform so well?



Overall improved lever mechanism gives the A700 an advantage

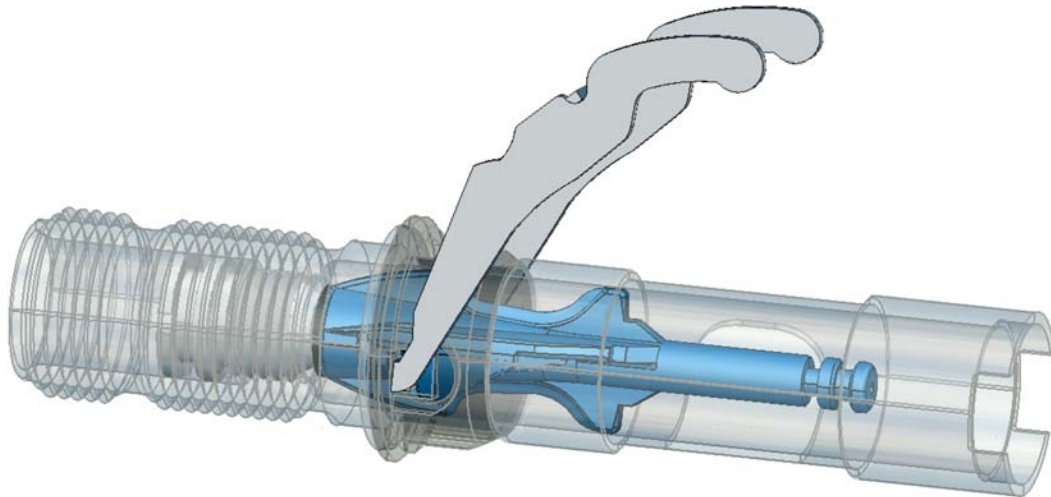

- The A700 lever is the same one as in our infallible S600 2nd stage, however, it functions on a **metal inlet tube**, allowing an increased stroke for better flow performance.
- The lever **stroke is higher** than usual, giving it great breathing performance at any depth.
- The A700 has been **laboratory tested at more than 100m** with breathing performance consistency !

Trouble-free exhaust



- Low exhaust effort is more important than inhalation effort. Our **large exhaust port** lets more air exit freely and **lowers the exhale effort**.
- High quality exhaust valve keeps the interior dry in any conditions
- Innovative exhaust system shape with specially designed airflow section, **keeps bubbles away from face and eyes**, so you don't miss a single scene underwater.

A700: Why does it perform so well?



Performance at your fingertips



- The **purge** button is large and easy-to-push, even with bulky gloves.
- A special low-friction plastic **disc is located on the diaphragm** and perfectly slides on the lever, guaranteeing smoother movement and more progressive airflow.
- A stainless steel plate creates the SCUBAPRO logo for robustness & style.

A700: Why does it perform so well?



Top Security for Top Safety



- A special “safety ring” is mounted between the diaphragm and purge button for an optimised seal.
- The entire assembly is tightened with cover screws. The perfect and maximum diaphragm distortion further reduces the W.O.B
- New Torx stainless steel cover screws maintain the high-tech styling and apply a higher tightening torque - - so no risk during maintenance or repairs.

Details make the Difference



- The “**superflow**” **hose** has a large internal section, allowing massive air flow and maximum reliability.
- Hose** is long term pressure tested up to 200 bars. Flexible black rubber outer layer makes it last longer and is more comfortable.
- Newly designed, more compact **hose protectors**, coordinated perfectly with the modern A700 style. The new smaller diameter allows more room to connect hoses.